

---

1、 Introduction:	-----	1
2、 Assembly:	-----	1
3、 Illustration:	-----	1
4、 Precaution:	-----	1
5、 keypad definition	-----	2
6、 Operation	-----	3
6.1 Switch on	-----	3
6.2 Zero	-----	3
6.3 Tare	-----	3
6.4 Sample and auto average	-----	3
6.5 Pre-tare	-----	3
7 Function operation	-----	4
7.1 linearity calibration	-----	4
7.2 Internal COUNT value display	-----	4
7.3 Single point calibration	-----	4
7.4 Unit switch	-----	5
7.5 Function setting	-----	5
8 Error message	-----	5

---

## 1. INTRODUCTION: ---

Thank your for purchasing our high resolution electronic scale. This scale enables you to measure the quality and weight. The scale is easy to operate, precision, stable and with fast display reaction. It is applicable in the electronic, hardware, plastic, medicine, textile and various other industries. It is useful for packaging, inventory and various production and quality control cases.

## 2. ASSEMBLY: ---

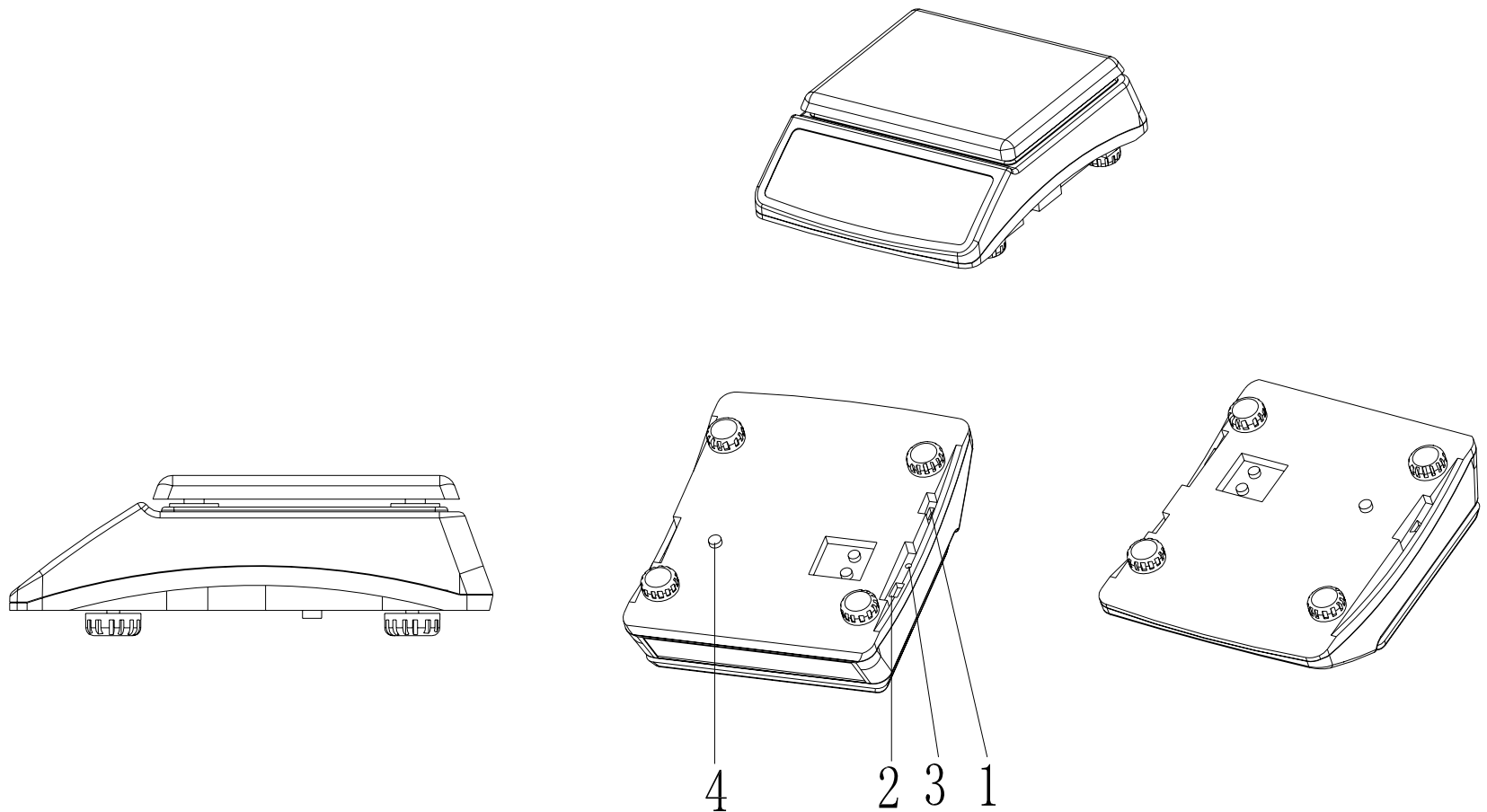

## 3. illustration: ---

- Assembly (please follow the sequence)
- Release and remove the protection screw 【4】 to resist the bottom housing.
- Remarks: assembly the protection device 【4】 before transportation the scale. This is for protecting the scale
- 【1】 Power switch
- 【2】 RS-232 interface
- 【3】 DC power socket
- 【4】 Shipping protection screw

## 4. Precaution: ---

- 1) full charge the battery after unpacking the scale
- 2) recharge the battery: when battery symbol appears on the LCD display, please plug in the power lord to charge the battery. The indicator of charge will light up in red. When it becomes green means charge completed( it takes about 8hours to full recharge the battery)\*
- 3) install the equipment on a level and stable surface.
- 4) do not install the equipment near the air condition or a vibrating machine.
- 5) Please in the temperature of 0°C~ 40°C , prevent from rapid temperature changes
- 6) independent AC outlet for this equipment is recommended, check the voltage before plug in.
- 7) warm up the equipment for 15 minutes before use

## 5. KEYPAD: ---

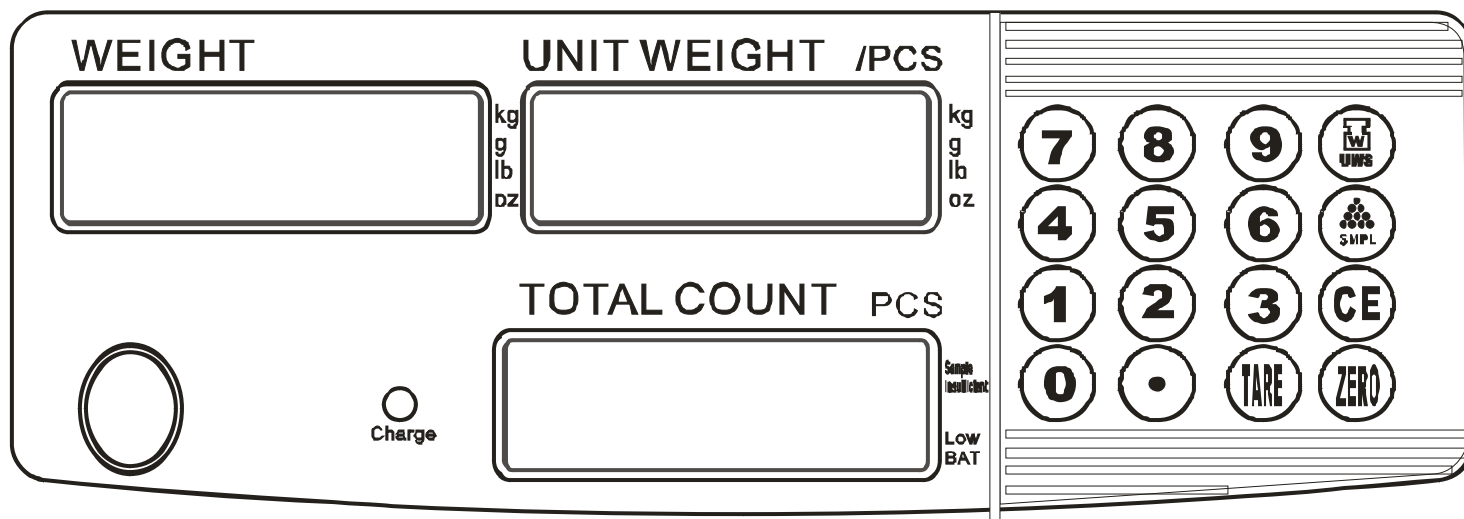

In the weighing mode: press this key, it only can come to zero when in  $\pm 2\%$  of max weighing capacity.

In the tare mode, press this key can cancel tare and come back to zero, when tare is less than  $\pm 2\%$  of max weighing capacity. When the tare is more than  $\pm 2\%$  of max weighing, press this key can cancel tare, but could not come to zero.



It can only tare when in the stable weighing mode,

Tare the weight of load on pan.

In the tare mode, press this key again to cancel tare.



Press[0]~[9] and press[sample], counting and display unit weight



Press[0]~[9] and [.] and press[UWS], could input unit weight.



when press this key, unit weight display shows 0.0.







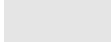

For unit weight setting, and value input for sample and pre-tare

---

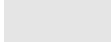
## 6. OPERATION:

### 6.1 SWITCH ON: ---

KEY	FUNCTION
	Enter into normal weighing mode
 + 	Enter Parameter setting
 + 	Enter linearity calibration
 + 	Enter single point calibration

### 6.2 ZERO: ---

Press  and come back to zero

- ✧ it works when less than  $\pm 2\%$  of max capacity.
- ✧ Press this key to cancel tare
- ✧ Press this key to cancel tare and come to zero

### 6.3 TARE: ---



In the stable weighing mode, press  to tare

- ✧ Can't work below zero (minus value) or above max capacity.
- ✧ In the tare mode press this key again and cancel tare. Display zero and stable symbol

### 6.4 SAMPLE AND AUTO AVERAGE ---







- ✧ Must be more than 10 pcs
- ✧ after sample, should load more than 3pcs on pan

### 6.5 PRE-TARE ---



- ✧ Input value and press  to tare
  - ✧ After tare, press  to cancel tare
-

## 7. OPERATION:







### 7.1 LINEARITY CALIBRATION -- (remarks: when CAL=1, could operation step by step.)

STEPS	ILLUMINATE
1	press  to switch on the scale, displays [CAL][LINE][3P]
2	press  , displays [CAL][LINE] [ON 0] to calibration zero.
3	press  , waiting for displaying [CAL][LINE] [ON 1], place 1/3 of load.
4	press  , waiting for [CAL][LINE] [ON 2], place 2/3 of load.
5	press  , waiting for displaying [CAL][LINE] [ON 3], place full load.
6	press  , waiting for [CAL][LINE] [PASS], finish calibration
7	press  , back to normal weighing mode









### 7.2 COUNT value display

STEPS	ILLUMINATE
1	press  to switch on the scale, displays [SCALE][FUNC][SET]
2	press  , displays [offset][ ][K X]
3	press  back to normal weighing mode













### 7.3 SINGLE POINT CALIBRATION

STEPS	ILLUMINATE
1	press  to switch on scales, displays [SET][ 0 ]
2	press   displays [SET][ 11]
3	press  displays [CAL][ON 0][ZERO] to calibration zero point.
4	Waiting for LCD displays [CAL][P][9]
5	Place weight and press  , choose calibration point
6	press  , begin calibration. displays [CAL][weight][CAP]
7	Waiting for LCD displays [CAL][PASS], finish calibration
8	press  back to normal weighing mode.

7.4 units conversion

STEPS	ILLUMINATE
1	press  to switch on scale, displays [SET][ 0]
2	press     , displays [SET][1132]
3	press  , displays [UNIT][SET][9]
4	press  , displays KG/G/LB/OZ in turn
5	press  back to normal weighing mode

7.5 **Function Setting**—(underline section is the initial setting)

STEPS	ILLUMINATE
1.	Press  to switch on scale and function setting. displays [SCALE][FUNC][SET]
2.	press  : LCD displays[FUNC0] [LIGH] [ONOFF] in turn, backlight setting: ON/OFF/ <u>ONOFF</u> , press  to setting in turn
3.	press  : LCD display [FUNC1] [TYPE] [DE] in turn. Division setting: DE/6000or 7500/15000, press  to setting in turn
4.	press  : LCD displays [FUNC2] [FILT] [-1-] in turn. Filter setting: 1、 <u>2</u> 、4、8, press  to set in turn
5.	press  : LCD displays [FUNC3] [2ZERO] [D0] in turn, zero band setting: D0/ <u>D1</u> /D2/D3/D4/D5, press  to set in turn
6.	press  : LCD displays [FUNCC] [SMPL] [D] in turn, counting mode choose: D、E, press  to set in turn
7.	press  , back to normal weighing mode

8. **ERROR MESSAGE:**

- 1) ERR3: over analysis area on A/D
- 2) ERR5: over load( max capacity +9e)
- 3) ERR6: over 10% of display weight when calibration
- 4) Battery symbol: low battery
- 5) LOBAT: low voltage